



READ AND SAVE THESE INSTRUCTIONS

Tower Circulator Owner's Guide

LEER Y GUARDAR ESTAS INSTRUCCIONES

Guía Del Propietario Del Ventilado Torre

LISEZ ET CONSERVEZ CES INSTRUCTIONS

Mode D'emploi Du Ventilateur Tour Pour Toute La Pièce

www.vornado.com

models 143 and 173

**Designed, engineered and supported in Andover, Kansas.
Pensado, diseñado y respaldado en Andover, Kansas.
Conception, mise au point et soutien technique effectués à Andover, au Kansa**

Questions or comments?
¿Preguntas o comentarios?
Questions ou commentaires?



www.vornado.com



consumerservice@vornado.com



800.234.0604

Important Instructions	4
Vornado V-Flow™ Circulation.....	6
Features and Benefits	7
Base Assembly Instructions	7
How To Use	8
Controls.....	9
Operating Tips	10
Cleaning and Storage	10
Troubleshooting	11
Warranty.....	12

IMPORTANT INSTRUCTIONS

READ ALL INSTRUCTIONS BEFORE USING THIS TOWER.

This appliance has a polarized plug. (One blade is wider than the other.) To reduce the risk of electrical shock, this plug is intended to fit in a polarized outlet only one way. If the plug does not fit fully in the outlet, reverse the plug. If it still does not fit, contact a qualified electrician. Do not attempt to defeat this safety feature.

WARNING – To reduce the risk of fire or electrical shock, do not use this product with any solid state speed control device. To reduce the risk of fire or electric shock and injury to persons, do not use in a window.

This product employs overload protection (fuse). A blown fuse indicates an overload or short-circuit situation. If the fuse blows, unplug the product from the outlet. Replace the fuse as per the user servicing instructions (follow product marking for proper fuse rating) and check the product. If the replacement fuse blows, a short-circuit may be present and the product should be discarded or returned to an authorized service facility for examination and/or repair.

- Do unplug your Tower Circulator before cleaning.
- Do clean your Vornado Tower Circulator regularly. Refer to the CLEANING instructions provided. Never clean the air circulator in any manner other than as instructed in this manual.
- Do Not use gasoline, thinners, solvents, ammonia or other chemicals for cleaning.
- Do Not immerse this product in water or allow water to drip into the motor housing.
- Do Not use near furnaces, fireplaces, stoves or other high-temperature heat sources.
- Do Not position this product too close to draperies because they may be drawn into the rear grill, cutting off airflow.
- Do Not use this product outdoors.

- Do Not use this product on wet surfaces.
- Do Not use this product in a bathtub or shower.
- Do Not use this product if it has a damaged cord or plug. Discard fan or return to an authorized service facility for examination and/or repair.
- Do Not carry this product by the cord, or use the cord as a handle.
- Do Not attempt to repair or replace parts.
- Do Not run cord under carpeting. Do Not cover cord with throw rugs, runners, or similar coverings. Do not route cord under furniture or appliances. Arrange cord away from traffic area and where it will not be tripped over.
- Do Not operate the Tower Circulator on an elevated surface, such as a shelf or desktop, use only while placed on the floor.
- Do use common sense when using this product and/or any electrical appliance.

User Servicing Instructions

Grasp plug and remove from the receptacle or other outlet device. Do not unplug by pulling on cord. Open fuse cover (A.) by sliding access cover on top of attachment plug towards blades. Remove fuse (B.) carefully by gently prying out the ends of the fuse from the receptacle.

Risk of fire. Replace fuse only with 2.5 Amp, 125 Volt fuse. Contact Vornado customer service for replacement fuse. Phone: 1-800-234-0604, email: consumerservice@vornado.com

Install replacement fuse (C.) by first placing the end of the fuse into the fuse receptacle which is opposite of the blades of the plug, then carefully push in the other end. Only push against the metal end of the fuse, not

IMPORTANT INSTRUCTIONS

READ ALL INSTRUCTIONS BEFORE USING THIS TOWER.

the glass center portion. Close the fuse access cover (D.) by sliding the cover back into the plug until it is completely closed, latched and is flush with the face of the plug. Risk of fire. Do not replace attachment plug. Contains a safety device (fuse, AFCI, LCDI) that should not be removed. Discard product if the attachment plug is damaged.

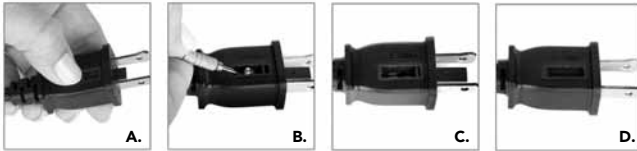

This unit requires one (1) lithium coin cell battery (CR2032), 3 Volt (included). DO NOT DISPOSE OF BATTERIES IN FIRE. BATTERIES MAY EXPLODE OR LEAK.

WARNING: KEEP BATTERIES AWAY FROM CHILDREN. If batteries are swallowed call the National Poison Control Center at 1-800-222-1222 or 202-625-3333. In Canada call 416-813-5900.

NOTE: This equipment has been tested and found to comply with the limits for Class B digital device, pursuant to part 15 of the FCC Rules. These limits are designed to provide reasonable protection against harmful interference in a residential installation. This equipment generates, uses and can radiate radio frequency energy and, if not installed and used in accordance with the instructions, may cause harmful interference to radio or television reception, which can be determined by turning the equipment off and on, the user is encouraged to try to correct

the interference by one or more of the following measures:

- Reorient or relocate the receiving antenna.
- Increase the separation between the equipment and the receiver.
- Connect the equipment into an outlet on a circuit different from that to which the receiver is connected.
- Consult the dealer or an experienced radio/TV technician for help.

This device complies with part 15 of the FCC Rules. Operation is subject to the following two conditions: (1) This device may not cause harmful interference, and (2) this device must accept any interference received, including interference that may cause undesired operation.

This Class B digital apparatus complies with Canadian ICES-003. Cet appareil numérique de la classe B est conforme à la norme NMB-003 du Canada.

SAVE THESE INSTRUCTIONS

Trust.

It is said that trust isn't given, but earned. For decades Vornado has been earning the trust of our customers by offering them only the best. Vornado provides the highest level of performance, coupled with the highest level of support available. Complete satisfaction with no exceptions – this is Vornado's promise to you. If you are not satisfied for any reason, please contact us. Knowledgeable representatives are available at 1-800-234-0604 from 7:00 AM to 6:00 PM CST. A wealth of additional support is also available online at www.vornado.com. On behalf of myself and the entire staff at our Andover, Kansas headquarters – thank you for selecting Vornado.

Sincerely,
Randy Brillhart
CEO, Vornado Air



Find our complete product line at www.vornado.com

Vornado V-Flow™ Circulation

Maximize your cooling and heating efficiency.

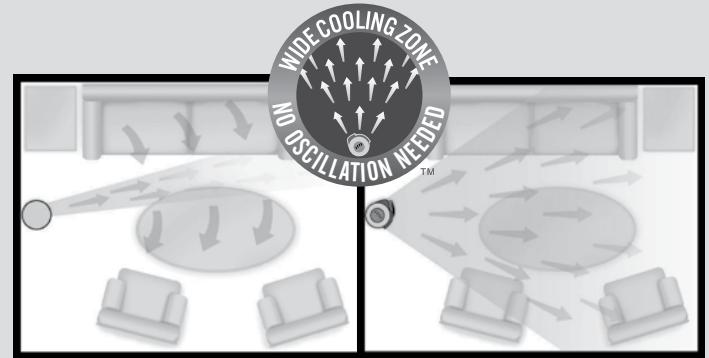

Typical Tower Fan

Typical tower fans oscillate due to limited range of air movement. You feel the airflow for only seconds at a time.

With V-Flow™ Circulation

V-Flow™ Circulation is a wide span of constant airflow that allows a Vornado to provide true whole room circulation.

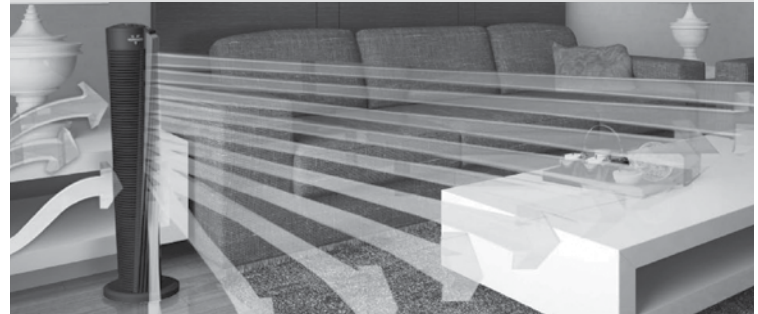

Features and Benefits

Feature



Multiple Speeds



Energy Saving Timer



Sturdy Base



Remote Control



Save Energy

Benefit

With push-button controls and multiple speeds, any circulation need will be met.

Timer is easily set to turn off the unit in 1, 2, 4, or 8 hours. Selected timer setting light will be illuminated.

Solid base design eliminates the typical wobble of common tower fans.

Remote control adds convenience, and stores easily atop the fan using a magnetic cradle.

Saves energy by maximizing the performance of cooling systems. When you use a Vornado Tower Circulator, you will not have to set your summertime thermostat as low.

Base Assembly Instructions

Tools Needed:

Phillips head screwdriver



1. Assemble the two base halves together. Position the base half with the alignment pin, over the other base half with the alignment sockets. Press the two halves together until flush. (See Figure A.)
2. Assemble the base to the tower bottom. With the Tower on its side, align the 4 base sockets onto the Tower bottom pins. With the base in position, secure the base bottom to the tower with the 4 Phillip screws provided. Tighten the screws securely but do not over tighten. (See Figure B)

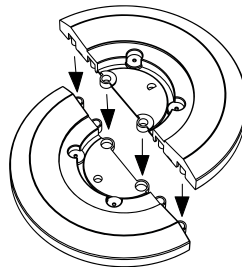

Figure A

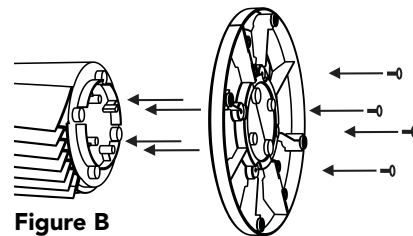

Figure B

How To Use

Positioning Your Circulator

1. Position your Tower Circulator so the airstream has an unobstructed path from one side of the room to the other, or position the airstream to blow directly at you for direct cooling.
2. Set to a medium speed and allow a few minutes for an airflow pattern to be established. (Different airflow patterns can be established by changing the location, and speed of the Tower Circulator.)
3. Adjust the speed accordingly until a desired comfort level is achieved. You will quickly determine the precise amount of circulation required to maintain your personal comfort in a given room for the prevailing temperature and humidity conditions. Once you discover the added comfort of air circulation, you will use your Vornado Tower Circulator season after season.

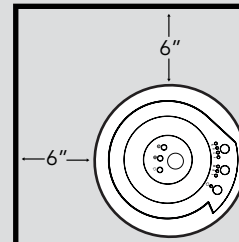

Figure A

Placement near a wall or corner
Please position at least 6" away from walls or other large surfaces. Doing so will ensure your Tower Circulator has adequate room to intake air, providing optimum performance. (See Figure A)

Directing the airflow

Unlike any other tower fan, this product creates a wide span of airflow called V-Flow™ Circulation. The Vornado logo indicates the center point of the V-Flow™ airstream, and can be used as a reference point for positioning the product in the room. (See Figure B)

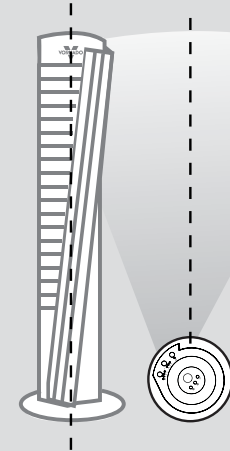
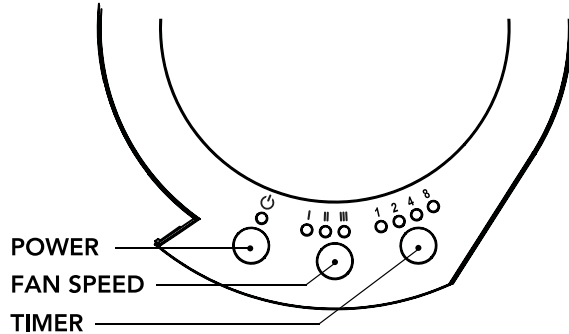
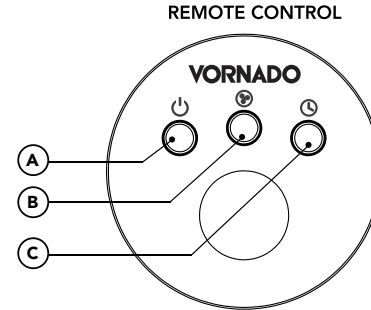

Figure B



- 1 Power** (A) The unit powers ON and OFF by pressing the POWER button. Lights on the unit's control panel indicate the power is ON.
- 2 Fan Speed** (B) The fan speed can be adjusted by pressing the SPEED button. Press the button to switch between the unit's speed settings. Lights on the unit's control panel indicate the selected speed setting.
- 3 Timer** (C) The unit has an automatic timer to turn the unit OFF at intervals of 1, 2, 4 or 8 hours. To set the timer, turn the unit on and select desired speed. Press the timer button until the desired run time light is illuminated. The unit will continue to run until that amount of time has expired.
- 4 Remote Control** This unit comes with a remote control. The remote control functions are the same as the control panel on the unit. The remote requires a line-of-sight path to allow for the signal to be received by the unit. Position the unit so the receiver lens (located above the Vornado logo) is visible from the remote



control. The remote control can be stored with the Tower Circulator using the magnetic bowl-shaped cradle located on the top of the product.

Remote Control Battery The remote control comes with a 3 Volt lithium coin cell battery (CR2032). To install, remove the battery cover on the bottom of the remote control. If necessary, clean the battery contacts and also those of the device prior to battery installation. Remove any plastic protection from the battery and place it in the remote with the + side facing out. Ensure the batteries are installed correctly with regard to polarity. Then reposition the cover onto the bottom of the remote. If your remote does not work, please try replacing with a new 3 Volt CR2032 battery, taking care to always use the correct size and grade of battery for this product.

Note: Remove the battery from the remote control when not in use for an extended period of time and always remove dead batteries immediately and replace with fresh. Do not store dead battery in remote.

Operating Tips

Getting the Most From Your Circulator

Thank you for your purchase. It's important for you to know that this product functions very differently than typical tower fans you may have used in the past. Here are a few things to keep in mind:

Expect Powerful Circulation

Your Tower Circulator is designed to move considerably more air than a traditional tower fan. Consider the following as you adjust product settings.

High Setting	High volume airflow. Rapidly moves air across the room for efficient cooling. Increased sound levels may be perceptible due to airflow volume and velocity.
Middle Setting	Superior circulation power compared to traditional tower fans on their high setting. May be preferred for day-to-day use.
Low Setting	Near-silent operation while offering steady circulation.

Cleaning and Storage

How to Clean

- Your Tower Circulator has no user serviceable parts. Do not disassemble the unit. This will void your warranty. If service is required, return your circulator to Vornado (see WARRANTY for instructions on page 12).
- The motor is permanently lubricated and requires no oiling.

Because your Tower Circulator moves a substantial amount of air, it will need regular cleaning. To clean follow these simple instructions:

1. Unplug the unit.

Note: Do not use gasoline, thinners, solvents or other chemicals for cleaning.

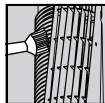

2. Use the brush attachment on your household vacuum cleaner to vacuum any accumulated dust off the Front Angled Outlet Grill and Side Inlet Grill. Wipe down the entire surface with a soft cloth.

Storage

It is recommended to store your Tower Circulator by following these instructions:

1. Unplug power cord and bundle loosely.
2. Thoroughly clean your Tower Circulator (see instructions above).
3. Cover, or place back in retail carton if available. This will prevent the unit from accumulating dust over time.
4. Store unit in a cool and dry location.

Troubleshooting

Problem	Possible Cause and Solution
Unit fails to power on.	Unit is not plugged in. Plug Power Cord into electrical outlet.
	Unit is damaged or in need of repair. Cease usage and unplug. Contact Consumer Service for assistance.
	Fuse needs to be replaced. See IMPORTANT INSTRUCTIONS for how to replace the fuse or contact Consumer Service.
Unit is not producing sufficient amount of air.	Ensure unit is set to highest setting for maximum air circulation.
	Allow the unit to fully circulate the air throughout the room, this may take several minutes.
	Ensure all air inlets and outlet grill are unobstructed.
Remote Control is not working.	The battery is packaged separately and may not be installed. Refer to CONTROLS - Remote Control Battery on page 9 for instructions.
	The battery is dead. Replace with new 3 volt CR2032 battery. Refer to CONTROLS - Remote Control Battery on page 9 for instructions.
	The remote requires a line-of-sight path to allow for the signal to be received by the unit. Position the unit so the receiver lens (located above the Vornado logo) is visible from the remote control.



Tower Circulator • 5 Year Limited Warranty

Vornado Air LLC ("Vornado") warrants to the original consumer or purchaser this Vornado® Tower Circulator ("Product") is free from defects in material or workmanship for a period of five (5) years from the date of purchase, depending on model. If any such defect is discovered within the warranty period, Vornado, at its discretion, will repair or replace the Product at no cost. Repairs not covered by the warranty or outside the warranty period will require a fee to cover the cost of materials, labor, handling and shipping.

This warranty does not apply to defects resulting from abuse of the Product, modification, alteration, repair or service of the Product by anyone other than Vornado, mishandling, improper maintenance, commercial use of the Product, damages which occur in shipment or are attributed to acts of God.

REPAIR OR REPLACEMENT AS PROVIDED UNDER THIS WARRANTY IS THE EXCLUSIVE REMEDY OF THE CONSUMER. VORNADO SHALL NOT BE LIABLE FOR ANY INCIDENTAL OR CONSEQUENTIAL DAMAGES FOR BREACH OF ANY EXPRESS OR IMPLIED WARRANTY ON THIS PRODUCT. EXCEPT TO THE EXTENT PROHIBITED BY APPLICABLE LAW, ANY IMPLIED WARRANTY OF MERCHANTABILITY OR FITNESS FOR A PARTICULAR PURPOSE ON THIS PRODUCT IS LIMITED IN DURATION TO THE DURATION OF THIS WARRANTY.

Some states do not allow the exclusion or limitation of incidental or consequential damages, or allow limitations on how long an implied warranty lasts, so the above limitations or exclusions may not apply to you. This warranty gives you specific legal rights, and you may have other rights that vary from state to state.

For warranty or repair service, call 1-800-234-0604 or email

consumerservice@vornado.com to obtain a Return Authorization ("RA") form. Please have or include your Product's model number and serial number, as well as your name, address, city, state, zip code and phone number when contacting Vornado for warranty service.

After receiving the RA form, ship your Product to:

Vornado Air LLC
Attn: Warranty & Repair
415 East 13th Street
Andover, KS 67002

For your convenience, please have your model number and serial number when contacting Vornado with service inquiries. To assure proper handling, packages must be clearly marked with the RA number. Packages not clearly marked with the RA number may be refused at the receiving dock.

Please allow 1-2 weeks for repair and return of your Product after the Product is received. For your records: Staple or attach your original sales receipt to this Owner's Guide. Please also write your product's serial number below (located on product specs decal).

Serial No. _____

Product registration available online at www.vornado.com

© 2015 Vornado Air LLC Andover, KS 67002

Patents Pending. Specifications subject to change without notice.

Vornado® is a trademark owned by Vornado Air LLC.

Designed, engineered and supported in Andover, KS.

Manufactured in China.

www.vornado.com consumerservice@vornado.com 800.234.0604



Vornado Air, LLC
415 East 13th Street, Andover, Kansas 67002
800.234.0604 | www.vornado.com

Speak your mind www.vornado.com/reviews
Hable con franqueza www.vornado.com/reviews
Exprimez-vous! www.vornado.com/reviews