



**5**  
YEAR

SATISFACTION  
GUARANTEE

model  
**PIVOT6**

WHOLE ROOM CIRCULATOR  
OWNER'S GUIDE

READ AND SAVE  
THESE INSTRUCTIONS

[vornado.com](http://vornado.com)

we expect  
this product  
to be **PERFECT**

if it's not  
**WE** will make  
it right.

vornado.com  
800.234.0604  
help@vornado.com

# CONTENTS

Important Safety Instructions .....	4
Features .....	8
How to Use .....	9
Remote Control.....	10
Cleaning .....	11
Troubleshooting .....	13
Warranty.....	14

## **READ AND SAVE THESE INSTRUCTIONS**

### **IMPORTANT SAFETY INSTRUCTIONS**

This owner's guide and any additional inserts are considered part of the product. They contain important information about safety, use and disposal. Before using the product, please familiarize yourself with all operating and safety instructions. Please keep all documents for future reference and pass these documents on, together with the product, to any future owner. See [www.vornado.com/circulators-manuals](http://www.vornado.com/circulators-manuals) to view, download and print the most current version of these instructions.

**INTENDED USE:** This product is intended to circulate the air in indoor living spaces only in the United States and Canada. This product is not intended for commercial or industrial use. The manufacturer assumes no responsibility for damage or injury due to unauthorized use or product modification. Failure to follow these directions will void the product warranty.

#### **WARNING: Risk to Children and Impaired Persons**

- Supervision is required during the installation, operation, cleaning and maintenance of this product by children age 12 years and younger and anyone with reduced physical, sensory or mental capabilities. Children should be supervised to ensure that they do not play with the appliance, its parts and packaging material.



#### **WARNING: Chemical burn hazard. Keep batteries away from children.**

- **WARNING: KEEP NEW AND USED BATTERIES AWAY FROM CHILDREN.** This product contains a lithium button/coin cell battery. If a new or used lithium button/coin cell battery is swallowed or

enters the body, it can cause severe internal burns and can lead to death in as little as 2 hours. Always completely secure the battery compartment. If the battery compartment does not close securely, stop using the product, remove the batteries, and keep it away from children. If you think batteries might have been swallowed or placed inside any part of the body, seek immediate medical attention. In the US call the National Poison Control Center at 1-800-222-1222 or 202-625-3333. In Canada call 416-813-5900.

#### **INSTALLATION WARNING—To reduce risk of fire, electrical shock and injury to persons, observe the following:**

- Place this product away from curtains, draperies, tablecloths and other fabrics, since they may be drawn into the fan, damage the motor and/or cause a fire.
- No part of this product (the appliance, power cord, plug, packaging, etc.) should be placed near furnaces, fireplaces, stoves or other high temperature heat sources. Do not use this product in a window, on an uneven or unstable surface, or near water.
- The appliance, power supply, power cord and plug cannot come into contact with water. Do not use this product on wet surfaces. Do not use this product in a bathtub or shower or position product where it may fall into a bathtub, laundry, swimming pool or other water container. Do not use this product outdoors or expose it weather or elements.
- Do not run cord under carpeting. Do not cover cord with throw rugs, runners, or similar coverings. Do not route cord under furniture or appliances. Arrange cord away from traffic area and where it will not be tripped over. The cord should not hang over edges of counters or be placed where it can be crimped or closed in doors. Place appliance near an easily accessible outlet so the product can be unplugged quickly during an emergency.
- Fan is intended for upright operation only; with base stand resting

on floor, desk or table. Do not elevate, place on uneven surface, or hang the product.

**SAFE USE WARNING—To reduce risk of fire, electrical shock and injury to persons, observe the following:**

- **WARNING:** To reduce likelihood of circuit overload, fire and electric shock, do not operate with a solid state speed device, such as a dimmer control switch.
- Do not operate any fan with a damaged cord or plug. Discard fan or return to an authorized service facility for examination and/or repair. Do not operate unit if it has been dropped or is damage is apparent to any part of the unit. To avoid risk of electrical shock, do not attempt to repair or replace parts. Only original replacement parts may be used. Contact Vornado Consumer Service at 1-800-234-0604 (phone) or consumerservice@vornado.com (email) for further instructions about replacement and repair.
- Risk of fire. Your appliance may be equipped with a detachable power supply or a cord/plug with a safety device such as a fuse. Use only the power cord and plug provided.
- Before plugging power cord into electrical outlet, be sure that all electrical information on the rating label, including voltage, is compatible with your outlet's power supply.
- Never use the cord as a handle or otherwise yank, strain or stretch the power cord.
- While the product is plugged in, do not insert or allow foreign objects to enter any input or output opening as this may cause risk of electric shock or fire, or damage the product.
- A loose fit between wall outlet (receptacle) and plug may cause overheating and distortion of the plug. Discontinue use of the product in this outlet. Contact a qualified electrician to replace loose or worn outlets.
- This appliance has a polarized plug (one blade is wider than the

other.) To reduce the risk of electrical shock, this plug is intended to fit in a polarized outlet only one way. If the plug does not fit fully in the outlet, reverse the plug. If it still does not fit, contact a qualified electrician. Do not attempt to defeat this safety feature.

- Before moving, repositioning, servicing, cleaning and when not in use, use the product controls to turn off the power and then unplug. To disconnect from outlet, grasp and pull only the plug. Also, power off and unplug if the product will be left unattended for an extended period of time or during electrical storms.

**SERVICING WARNING—To reduce risk of fire, electrical shock and injury to persons, observe the following:**

- Clean your product regularly, only as is instructed in this manual. Prior to cleaning, turn off the power on your product and unplug. Do not use gasoline, thinners, solvents, ammonias or other chemicals for cleaning. Refer to the CLEANING instructions provided.
- Do not open appliance housing. To avoid risk of shock, all service and/or repairs must be done by a Vornado Authorized Service Center.
- This product employs overload protection (fuse). A blown fuse indicates an overload or short-circuit situation. If the fuse blows, unplug the product from the outlet. Replace the fuse as per the user servicing instructions (follow product marking for proper fuse rating) and check the product. If the replacement fuse blows, a short-circuit may be present and the product should be discarded or returned to an authorized service facility for examination and/or repair.

**User Servicing Instructions**

1. Using the product controls, turn off the appliance.
2. Grasp the plug (not the cord) and disconnect from the outlet.
3. Risk of Fire. Replace fuse only with 2.5 Amp, 125 Volt fuse as approved by Vornado Consumer Service. For an authorized

- replacement fuse, please contact Vornado Consumer Service.
- Once the replacement is received, use a small flat-head screwdriver to slide open the fuse cover (located on the plug) (See Fig. A).
  - Remove fuse by using the screwdriver to gently lift each end of the fuse (See Fig. B).
  - Install the replacement fuse by using the screwdriver to gently push each metal end of the fuse into the receptacle one at a time. Do not push on the center of the fuse—it is fragile and may break.
  - Slide the fuse cover closed using the screwdriver. When closed, the cover should fit completely in the plug. No part of the cover should stick out (See Fig. C).
  - Plug your appliance into the outlet and turn the power on.
  - If the replacement fuse blows, a short-circuit may be present and the product should be discarded or returned to an authorized service facility for examination and/or repair.

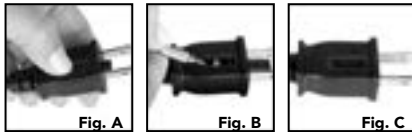

Risk of fire. Do not replace attachment plug. Contains a safety device (fuse, AFCI, LCDI) that should not be removed. Discard product if the attachment plug is damaged.

### FCC Compliance Statement

This device complies with Part 15 of the FCC Rules. Operation is subject to the following two conditions: (1) This device may not cause harmful interference, and (2) this device must accept any interference received, including interference that may cause undesired operation.

**NOTE:** This equipment has been tested and found to comply with the limits for a Class B digital device, pursuant to part 15 of the FCC Rules. These limits are designed to provide reasonable protection against harmful interference in a residential installation. This equipment generates, uses and can radiate radio frequency energy and, if not installed and used in accordance with the instructions, may cause harmful interference to radio communications. However, there is no guarantee that interference will not occur in a particular installation. If this equipment does cause harmful interference to radio or television reception, which can be determined by turning the equipment off and on, the user is encouraged to try to correct the interference by one or more of the following measures:

- Reorient or relocate the receiving antenna.
- Increase the separation between the equipment and receiver.
- Connect the equipment into an outlet on a circuit different from that to which the receiver is connected.
- Contact Vornado Customer Service or dealer or an experienced radio/TV technician for help.

This Class B digital apparatus complies with Canadian ICES-003.

Changes or modifications not expressly approved by the party responsible for compliance could void the user's authority to operate the equipment.

### Supplier's FCC Declaration of Conformity

Unique Identifier: Vornado Model PIVOT6

Responsible Party: Vornado Air LLC

Mailing Address: 415 E. 13th St., Andover, KS 67002

Contact: [www.vornado.com](http://www.vornado.com)

**BATTERY DISPOSAL:** Please dispose of batteries according to the local laws and regulations of your region, and while keeping them away from children. Some batteries may be recycled and accepted for disposal at your local recycling center. **DO NOT DISPOSE OF BATTERIES IN FIRE. BATTERIES MAY EXPLODE OR LEAK.** New and used batteries may cause injury. Keep new and used cells (or batteries) away from children.



**PACKAGE RECYCLING:** The packaging protects the appliance from transport damage. Dispose of all packaging materials in an environmentally responsible manner.

**SAVE THESE INSTRUCTIONS**

# FEATURES



Save energy by maximizing the performance of heating and cooling systems. When you use a Vornado Circulator, you will not have to set your summertime thermostat as low or your wintertime thermostat as high.

## FINGER FRIENDLY DESIGN

Resists curious fingers.

## PIVOT

Direct the airflow where you want it.

## AIR INLETS

Signature inlets and powerful motor to move more air.

## MULTIPLE SPEEDS

Speed setting for every comfort level.

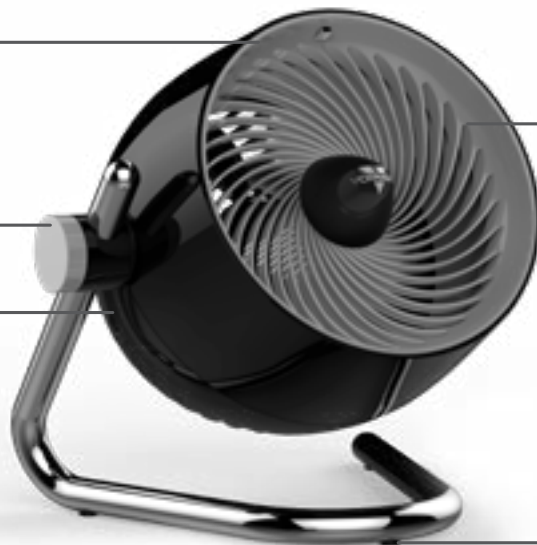

## REMOVABLE GRILLE

For easy cleaning.



## REMOTE CONTROL



Convenience at your fingertips.

## SILICONE FEET

Non-marking feet added for stability.



# HOW TO USE

1. Touch  to power on.
2. Select desired speed by pressing : High, Med High, Medium, Low
3. Touch  to power off.

POWER ON/OFF 

FAN SPEED 



# REMOTE CONTROL

## REMOTE FUNCTIONS

1. Press  to power on.
2. Select desired speed setting by pressing -/+ button.

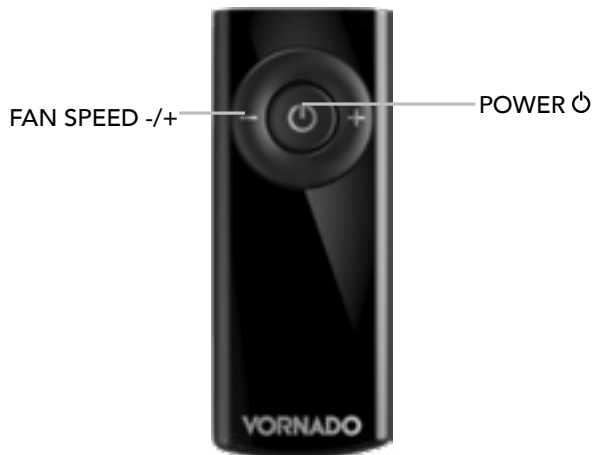

**Note:** The remote requires a line-of-sight path to allow for the signal to be received by the product. Position the product so the receiver lens (located at the top of the grille) is visible from the remote control.

## BATTERY REPLACEMENT

Your circulator remote includes (1) coin style 3V CR2032 battery. Battery comes pre-installed. Remove battery pull tab before first use.

1. For battery replacement, the remote requires one coin style 3V CR2032 battery. Always use the correct size and grade of battery for this product.
2. To replace battery, open battery door on the back side of the remote control (you will need to loosen the small screw on door using a #1 Phillips screwdriver). If necessary, clean the battery contacts and also those of the device prior to battery installation. Remove any plastic protection from the battery and place it in the remote with the + side facing out. Ensure the battery is installed correctly with regard to polarity. Replace the battery door and screw.

**Note:** Remove battery from the remote control when not in use for an extended period of time and always remove dead battery immediately and replace with fresh. Do not store dead battery in remote.

# CLEANING

## GRILLE REMOVAL *Screwdriver required.*

**⚠️ WARNING:** To reduce the risk of electrical shock and injury to persons, unplug the circulator before removing grille.

1. Remove the 3 screws located in between the ribs of the inlet grille at roughly 2, 5 and 9 o'clock positions. Screw locations are also indicated with an arrow (→) on the circulator.
2. Dust or wash Front Grille with a mild dishwashing soap. Do not place grille in the dishwasher. The excessive heat can distort the plastic.
3. To reattach - position the Front Grille so the Vornado logo in the center of the Front Grille is straight. Replace all the screws.

**Tip** Use the brush attachment on your household vacuum cleaner to vacuum any accumulated dust off the Front Grille and Air Inlets.

**Note:** The motor is permanently lubricated and requires no oiling.



# CLEANING

## BLADE REMOVAL *Pliers required.*



**⚠️ WARNING:** To reduce the risk of electrical shock and injury to persons, unplug the circulator before removing blade.

1. First, remove the nut from the shaft by turning the nut **clockwise** to loosen. Pull the blade straight out from the shaft.
2. Wipe the Blade with a damp cloth. If your circulator is used in a greasy environment, such as a kitchen, mild soap or a common household cleaner may be necessary. Do not use solvents. Do not place blade in the dishwasher. The excessive heat can distort the plastic.
3. To reattach - be certain the flat side of the shaft aligns directly with the corresponding flat side on the blade's socket. Push the blade all the way on the shaft until it bottoms out. **Do not use a hammer as this could result in bearing damage.** Reinstall nut.

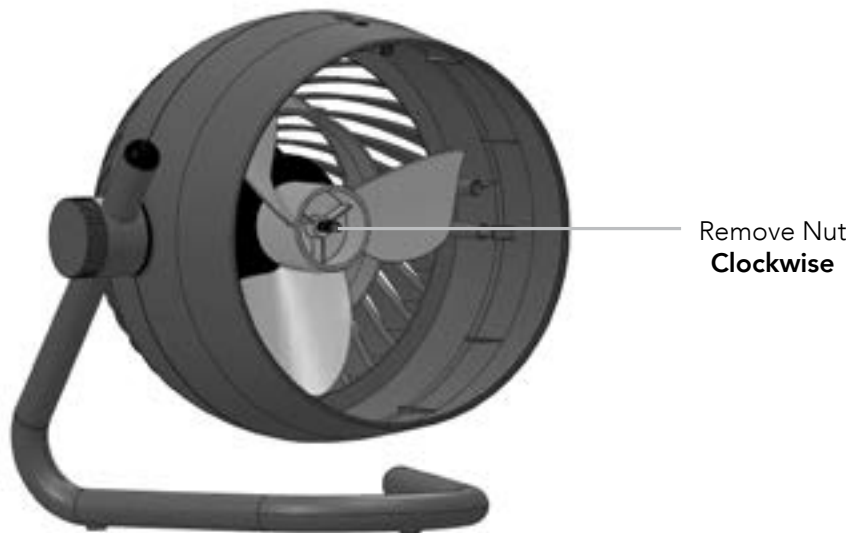

# TROUBLESHOOTING

## PROBLEM

## POSSIBLE CAUSE AND SOLUTION

The unit fails to power on.

Unit is not plugged in. Plug Power Cord into electrical outlet.

Ensure unit fan speed setting is selected.

Plug fuse has blown. Replace fuse (See USER SERVICING INSTRUCTIONS on page 5).

Unit is damaged or in need of repair. Cease usage and unplug. Contact Consumer Service for assistance.

The outlet is worn or damaged. Try another outlet or contact a qualified electrician.

Airflow is weak or slow.

Unit set to a low speed setting. Adjust to a higher speed setting.

Airflow is blocked. Remove obstruction.

Adjust direction of airflow towards the user.

GFCI has tripped.

Under certain conditions, it is possible for a reset GFCI (Ground Fault Circuit Interrupter) outlet to trip when the user is changing speeds on a Vornado circulator. In this event, change to an outlet that is not connected to a GFCI device. It could also indicate a weak or defective GFCI outlet. Contact a qualified electrician to check the GFCI outlet.



# WARRANTY

We expect this product to be perfect. If you're not satisfied with this product, let us know.

**We're Here To Help**  
**800.234.0604**  
**vornado.com**  
**help@vornado.com**

Vornado Air LLC ("Vornado") warrants to the original consumer or purchaser this Vornado® Whole room Circulator ("Product") is free from defects in material or workmanship for a period of five (5) years from the date of purchase. If any such defect is discovered within the warranty period, Vornado, at its discretion, will repair or replace the Product at no cost.

For warranty or repair service: Call 1-800-234-0604 or email [help@vornado.com](mailto:help@vornado.com) to obtain a Return Authorization ("RA") form. Please have or include your Product's model number and serial number, as well as your name, address, city, state, zip code and phone number when contacting Vornado for warranty service.

After receiving the RA form, ship your Product to: Vornado Air LLC Attn: Warranty & Repair 415 East 13th Street Andover, KS 67002. For your convenience, please have your model number and serial number when contacting Vornado with service inquiries. To assure proper handling, packages must be clearly marked with the RA number. Packages not clearly marked with the RA number may be refused at the receiving dock. Please allow 1-2 weeks for repair and return of your Product after the Product is received.

Repairs not covered by the warranty or outside the warranty period will require a fee to cover the cost of materials, labor, handling and shipping.

This warranty does not apply to defects resulting from abuse of the Product, modification, alteration, mishandling, improper maintenance, commercial use or repair or service of the Product by anyone other than Vornado; damages which occur in shipment or are attributed to acts of God. Improper product use, which includes using an external device that

alters or converts the voltage or frequency of electricity, or shipping a Vornado product to a country not intended for use will void all warranties. Any unauthorized product modification, repair by unauthorized repair center, or use of non-approved replacement parts is not recommended and any consequences will not be covered by support services or product warranties. The product warranty will be honored only on models that are being used in the country intended. REPAIR OR REPLACEMENT AS PROVIDED UNDER THIS WARRANTY IS THE EXCLUSIVE REMEDY OF THE CONSUMER. VORNADO SHALL NOT BE LIABLE FOR ANY INCIDENTAL OR CONSEQUENTIAL DAMAGES FOR BREACH OF ANY EXPRESS OR IMPLIED WARRANTY ON THIS PRODUCT. EXCEPT TO THE EXTENT PROHIBITED BY APPLICABLE LAW, ANY IMPLIED WARRANTY OF MERCHANTABILITY OR FITNESS FOR A PARTICULAR PURPOSE ON THIS PRODUCT IS LIMITED IN DURATION TO THE DURATION OF THIS WARRANTY. Some states do not allow the exclusion or limitation of incidental or consequential damages, or allow limitations on how long an implied warranty lasts, so the above limitations or exclusions may not apply to you. This warranty gives you specific legal rights, and you may have other rights that vary from state to state. The manufacturer assumes no responsibility for damage caused by failure to follow these instructions or improper product use. Any such actions will invalidate the product warranty.

All company names and product names are trademarks of their respective owners. © All rights reserved. All technical information, data, and instructions for the installation, connection, and operation contained in these instructions for use correspond to the latest available information at time of printing. The contents of this manual may differ slightly from the actual product. Observe any additional supplements.



Designed, engineered and supported in Andover, KS

© 2020 Vornado Air LLC Andover, KS 67002 U.S. Patent Pending. Specifications subject to change without notice. Vornado® is a trademark owned by Vornado Air LLC.



Vornado Air, LLC  
415 East 13th Street, Andover, Kansas 67002  
800.234.0604 | [vornado.com](http://vornado.com)